

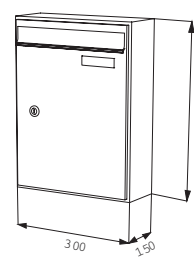

FICHE TECHNIQUE

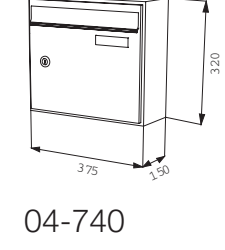

Modèles standards

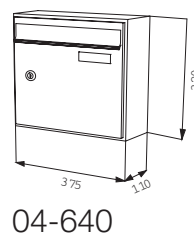
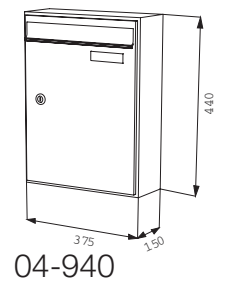
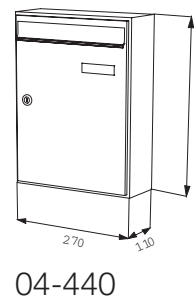
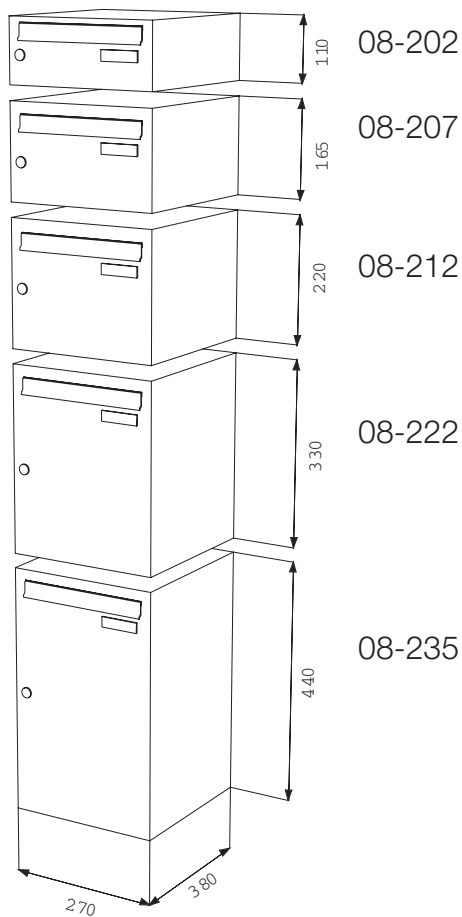
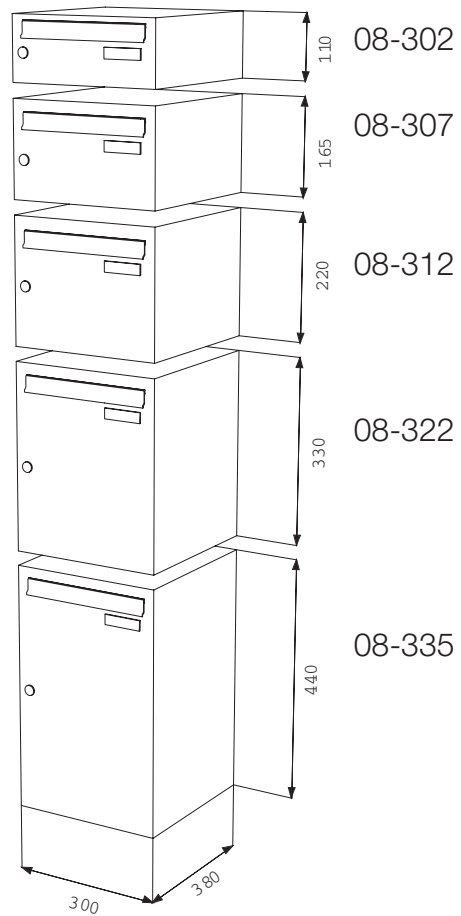
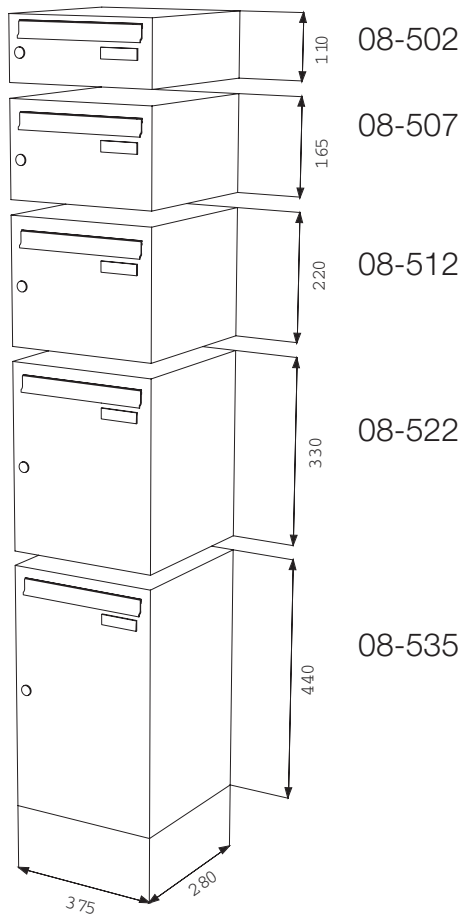

Finitions 04 & 08

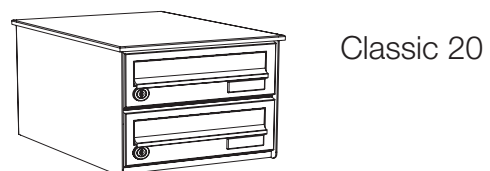
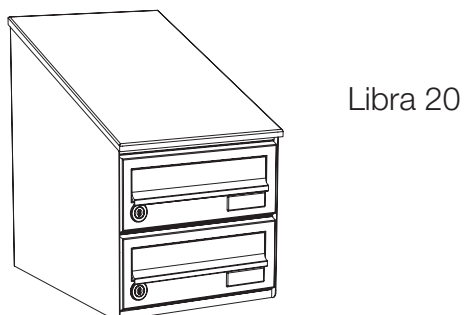
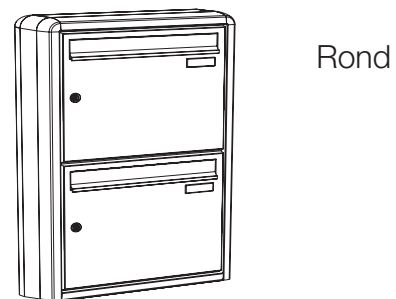
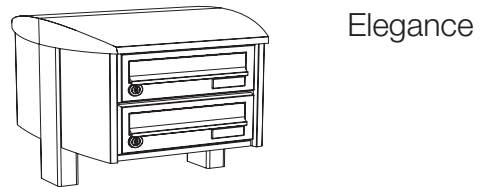
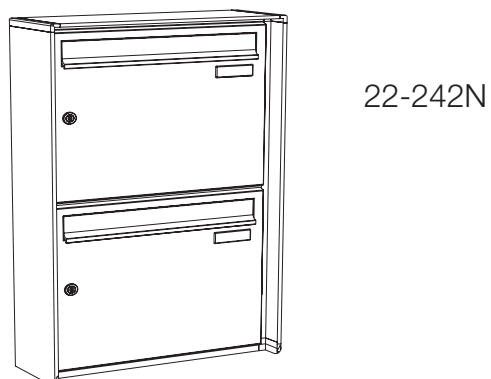
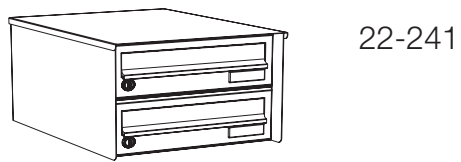
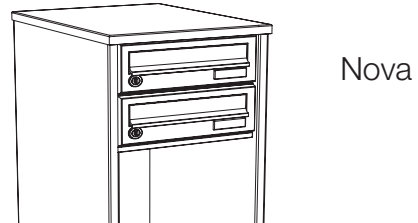
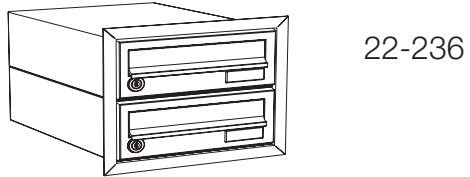
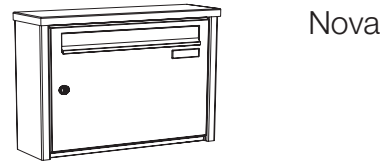
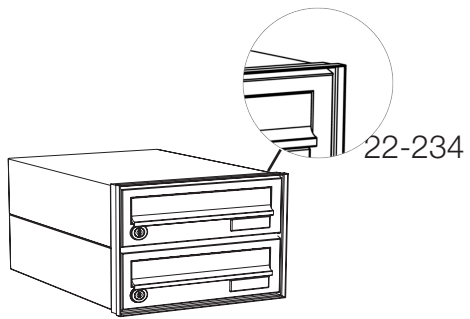

Pieds

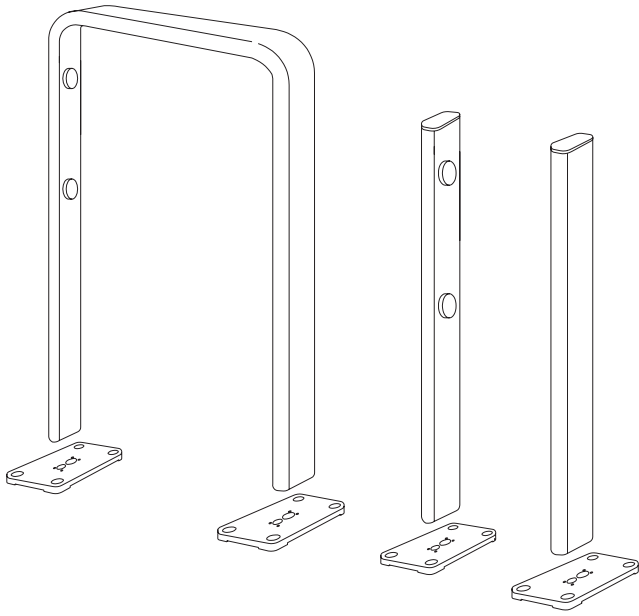

114x50 mm

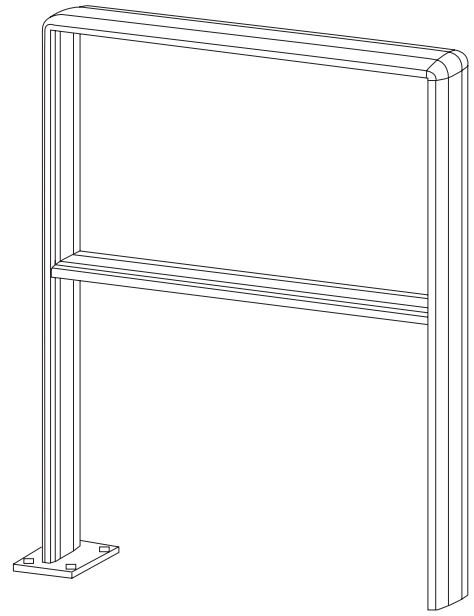

130x30 mm

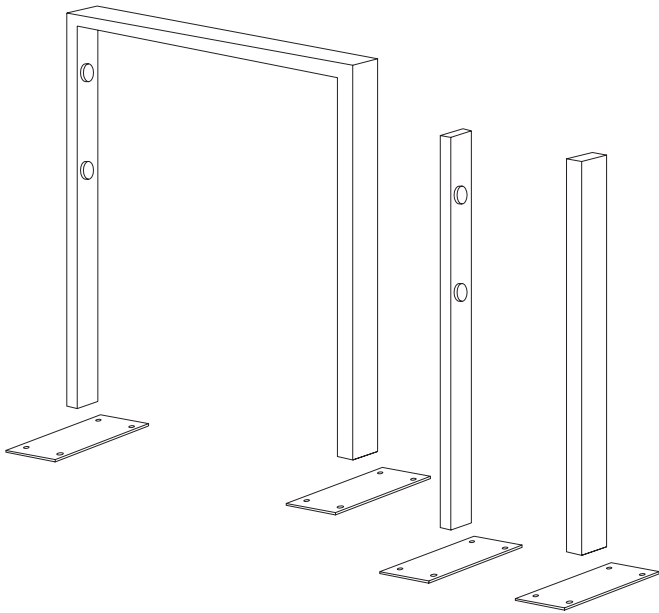

80x40 mm

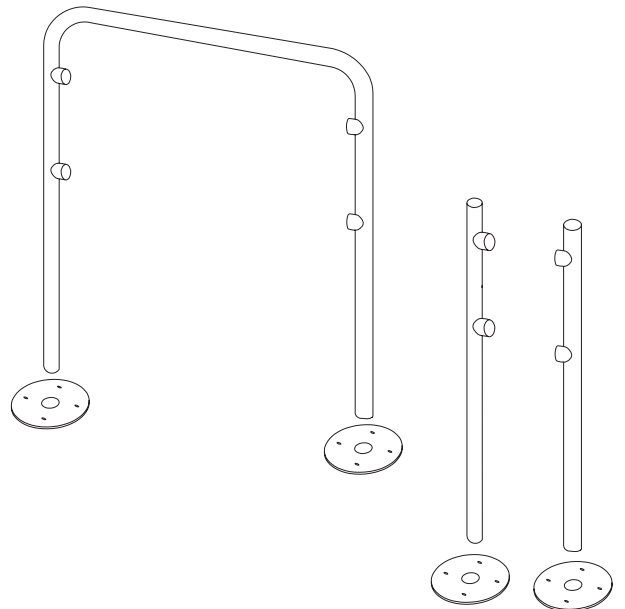

diamètre: 60 mm



AvantGarde

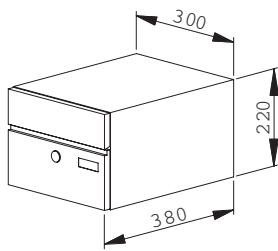

05-500

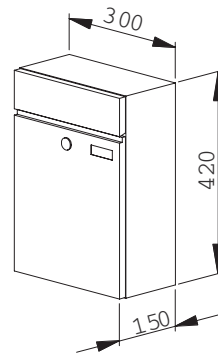

05-100

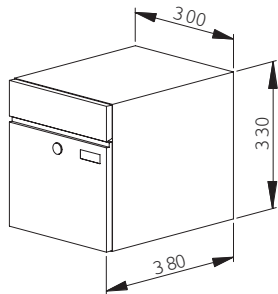

05-520

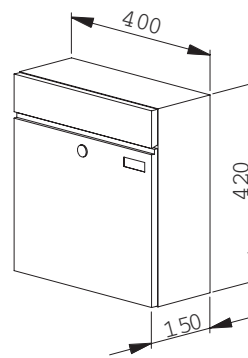

05-300

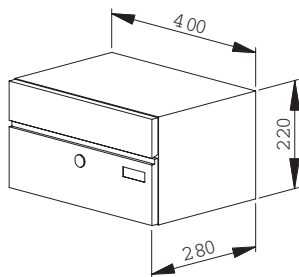

05-700

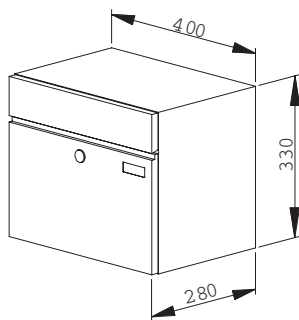

05-720

Finitions AvantGarde



Nova
pose libre



22-542

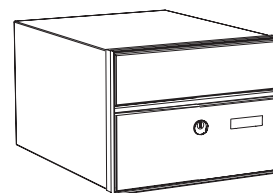

22-560
encastré

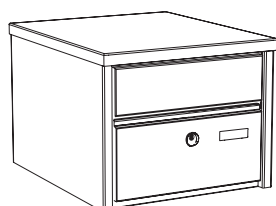

Nova

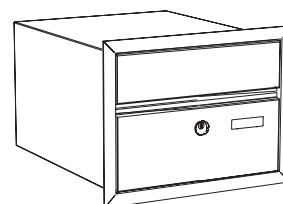

22-520
encastré



Boîtes aux lettres pour traverser

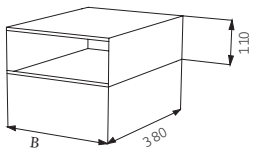

B: 270 mm | 02-741
B: 300 mm | 02-841

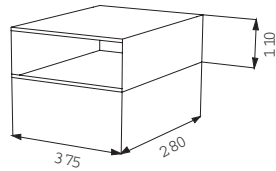

02-941

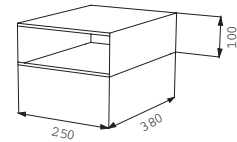

02-112

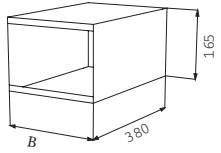

B: 270 mm | 02-744
B: 300 mm | 02-844

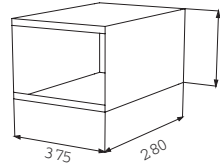

02-944

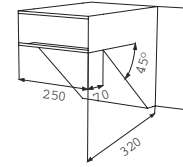

02-113

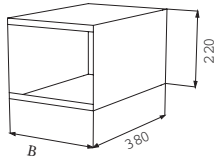

B: 270 mm | 02-742
B: 300 mm | 02-842

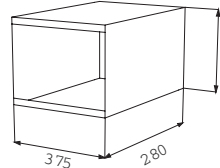

02-942

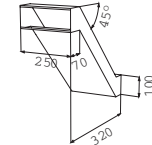

02-115

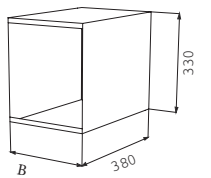

B: 270 mm | 02-743
B: 300 mm | 02-843

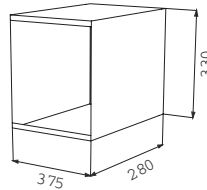

02-943

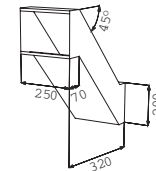

02-128

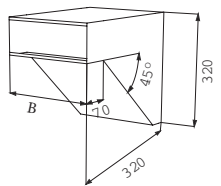

B: 270 mm | 02-746
B: 300 mm | 02-846
B: 375 mm | 02-946

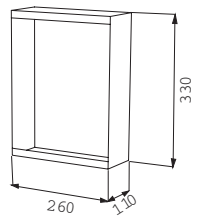

02-251

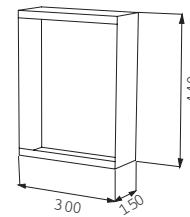

02-401

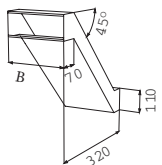

B: 270 mm | 02-747
B: 300 mm | 02-847
B: 375 mm | 02-947

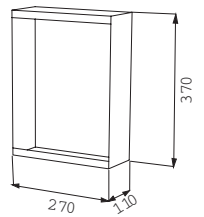

02-331

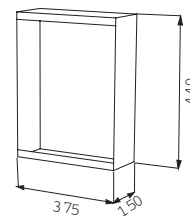

02-431

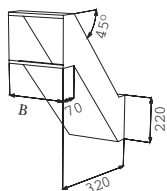

B: 270 mm | 02-748
B: 300 mm | 02-848
B: 375 mm | 02-948

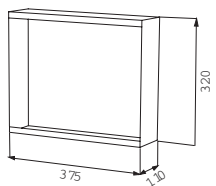

02-351

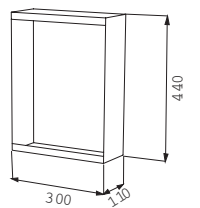

02-391

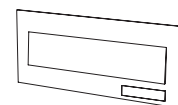

230 mm
250 mm
280 mm
355 mm

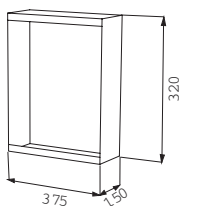

02-361

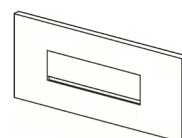

230 mm
250 mm
280 mm
355 mm

